

IMPLANTAÇÃO GERAL  
ESC 1/900

LEGENDAS

- BL - BOCA DE LOBO
- FLUXO DE ÁGUAS PLUVIAS
- PAVIMENTO ASFALTICO - ESP. 03cm
- PAVIMENTO ASFALTICO - ESP. 05cm
- EDIFICAÇÕES EXISTENTES
- FECHAMENTO EM ALAMBRAÇO

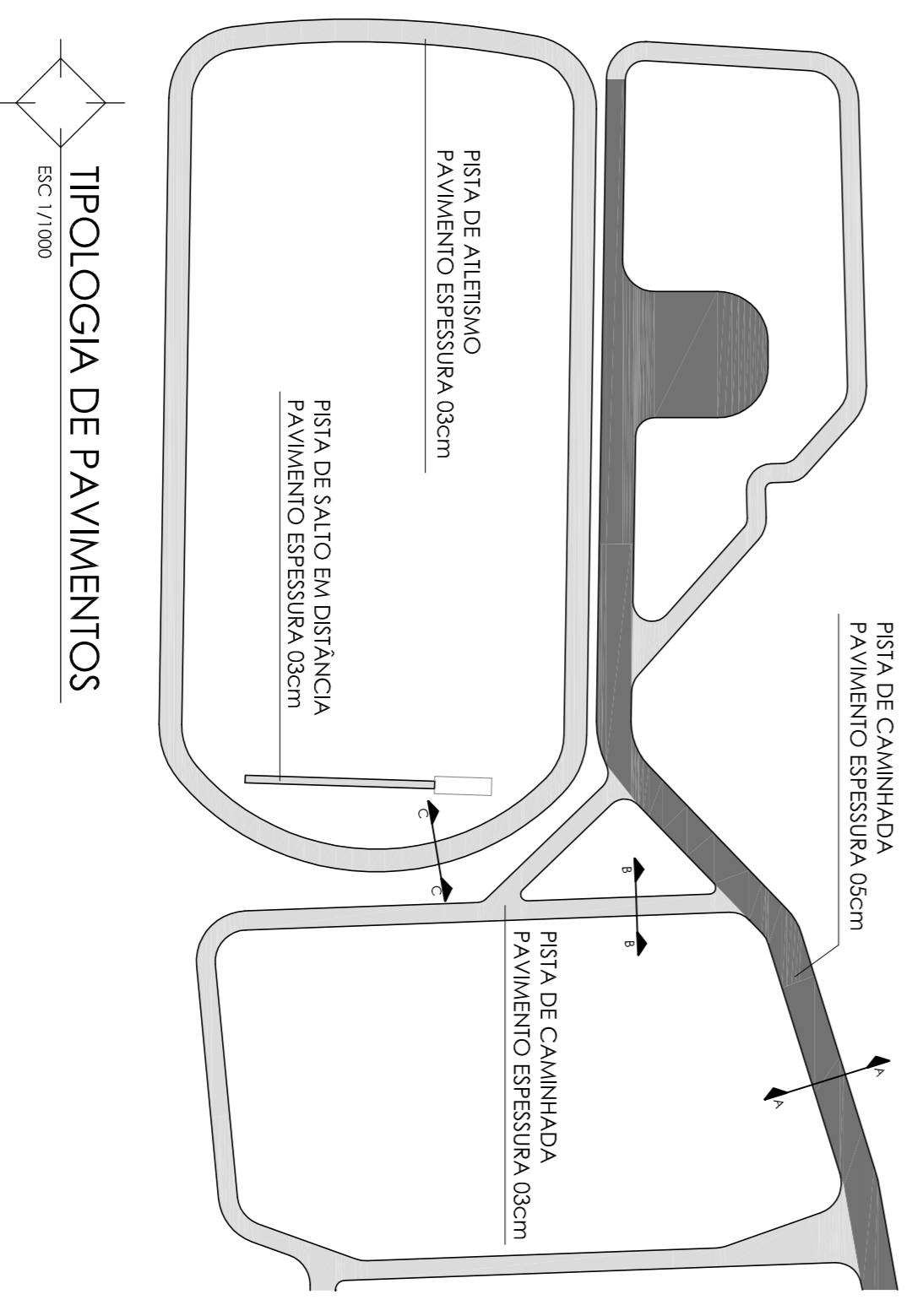

TIPOLOGIA DE PAVIMENTOS  
ESC 1/1000

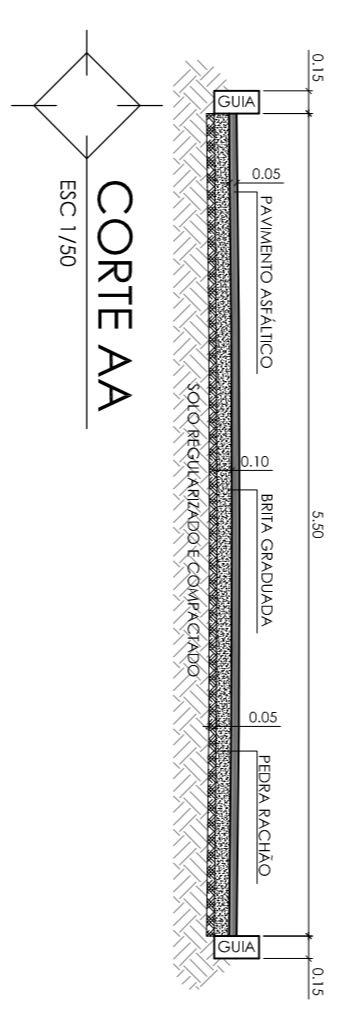

CORTE AA  
ESC 1/50

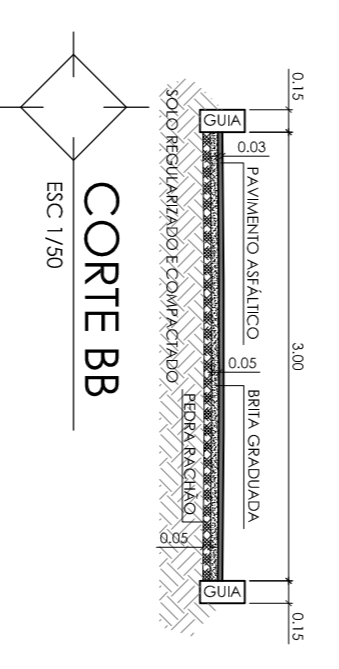

CORTE BB  
ESC 1/50

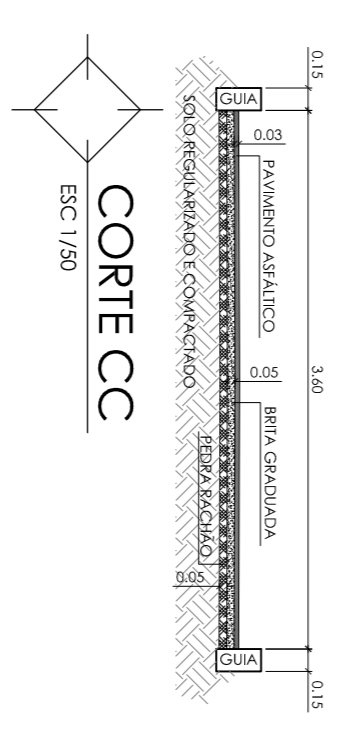

CORTE CC  
ESC 1/50

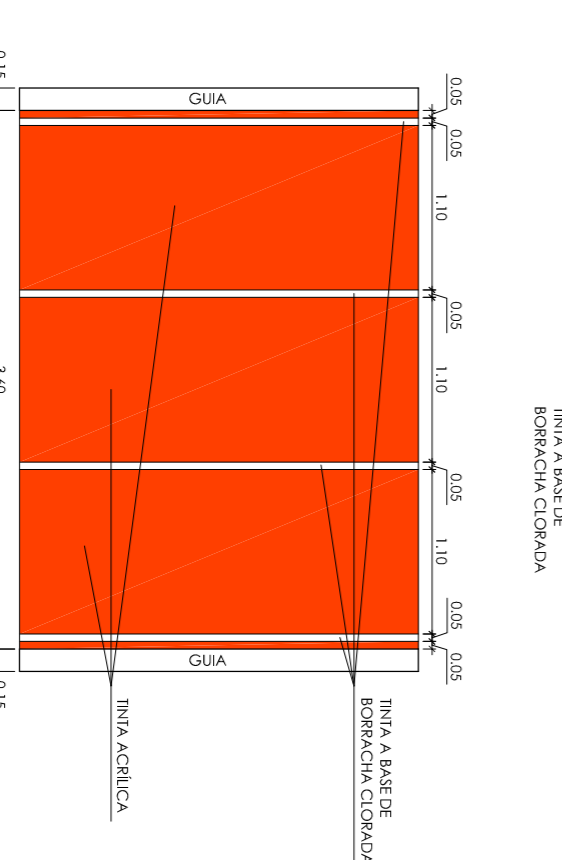

DETALHE - PISTA DE CORRIDA  
ESC 1/50

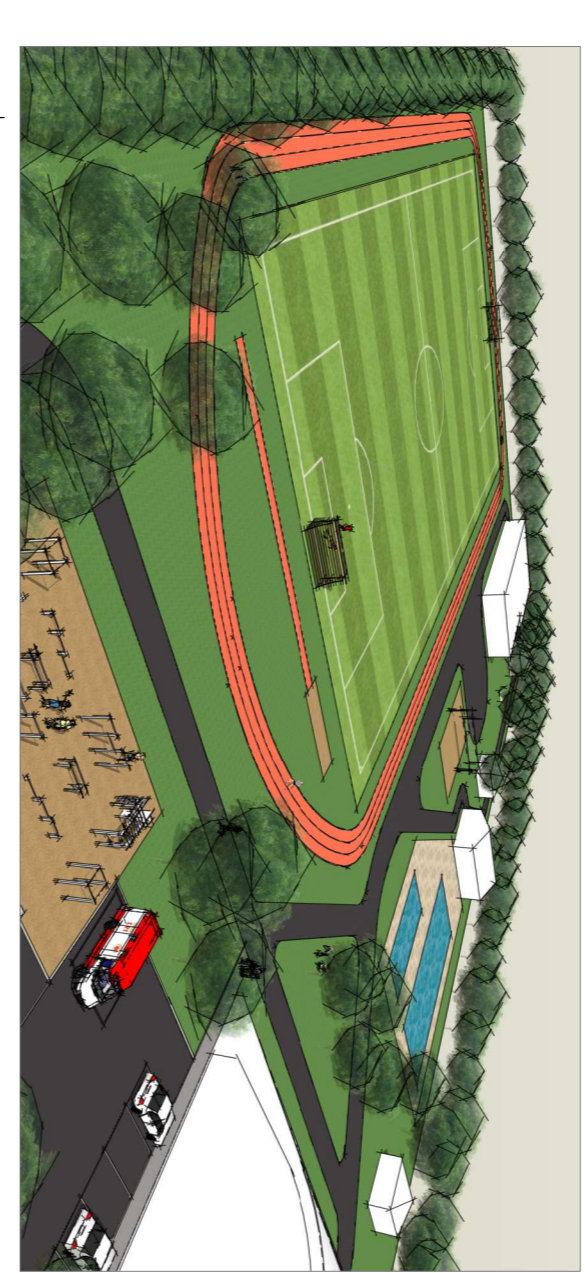
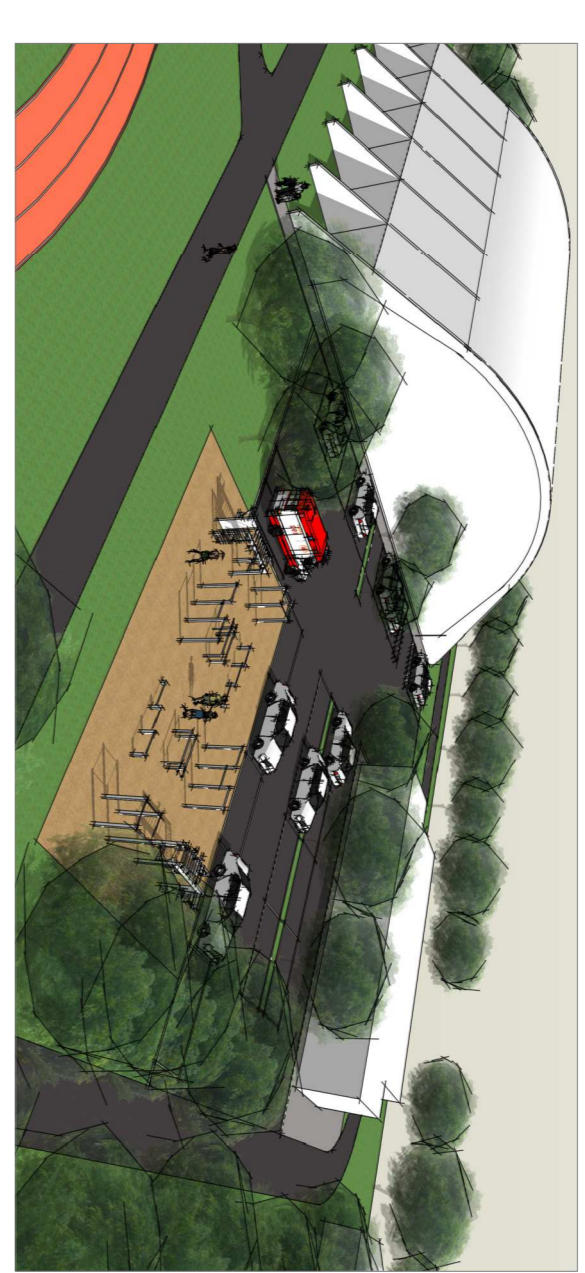
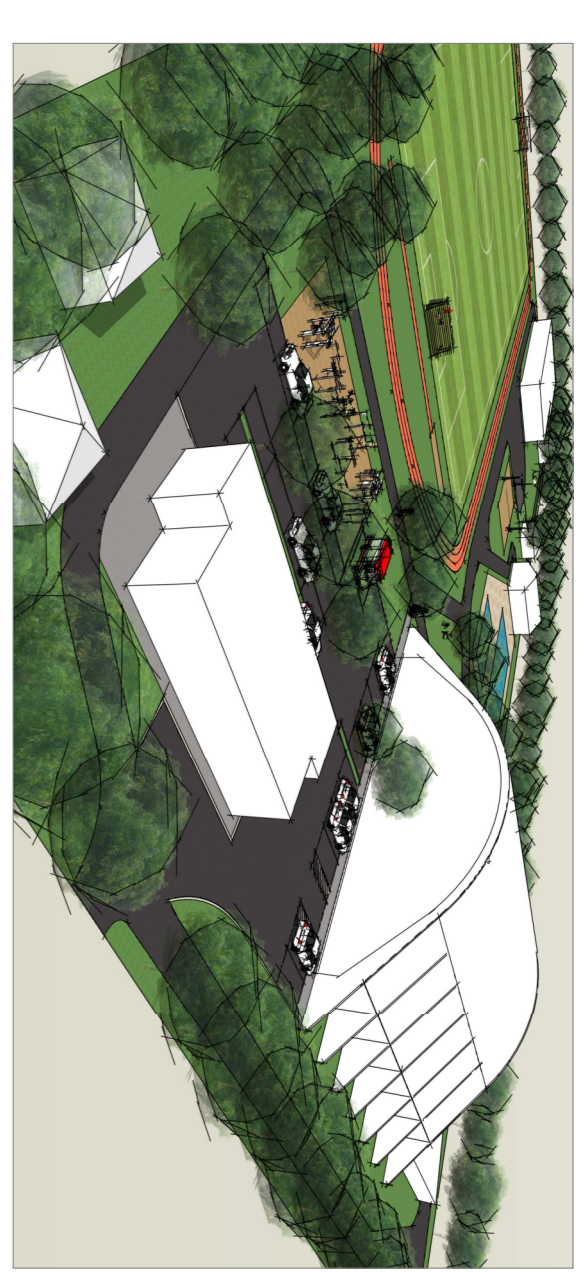

PERSPECTIVAS ILUSTRADAS  
SEM ESCALA

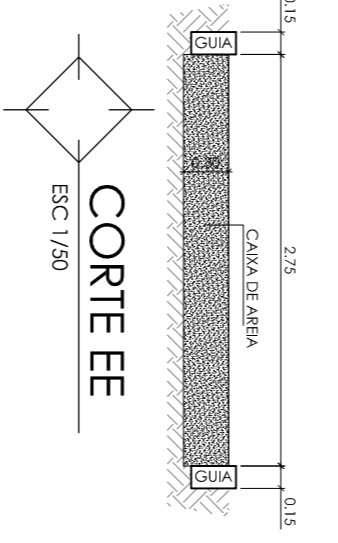

CORTE EE  
ESC 1/50

NOTA:

TABUA DE IMPULSAO 1,22 X 0,20 X 0,10 (LARGURA X COMPRIMENTO X ESPESURA).  
MEDIDAS EM METROS.  
FIXAR COM PREGOS CHUMBADOS.

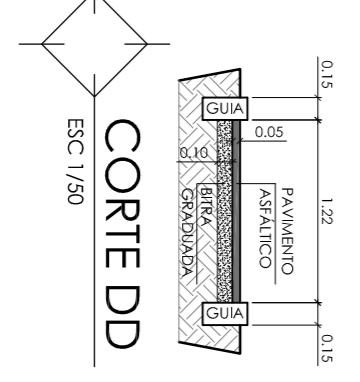
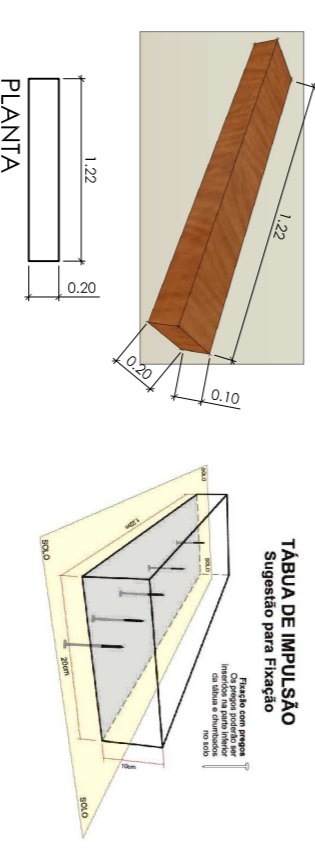

CORTE DD  
ESC 1/50

DETALHE - PISTA DE SALTO  
ESC 1/200

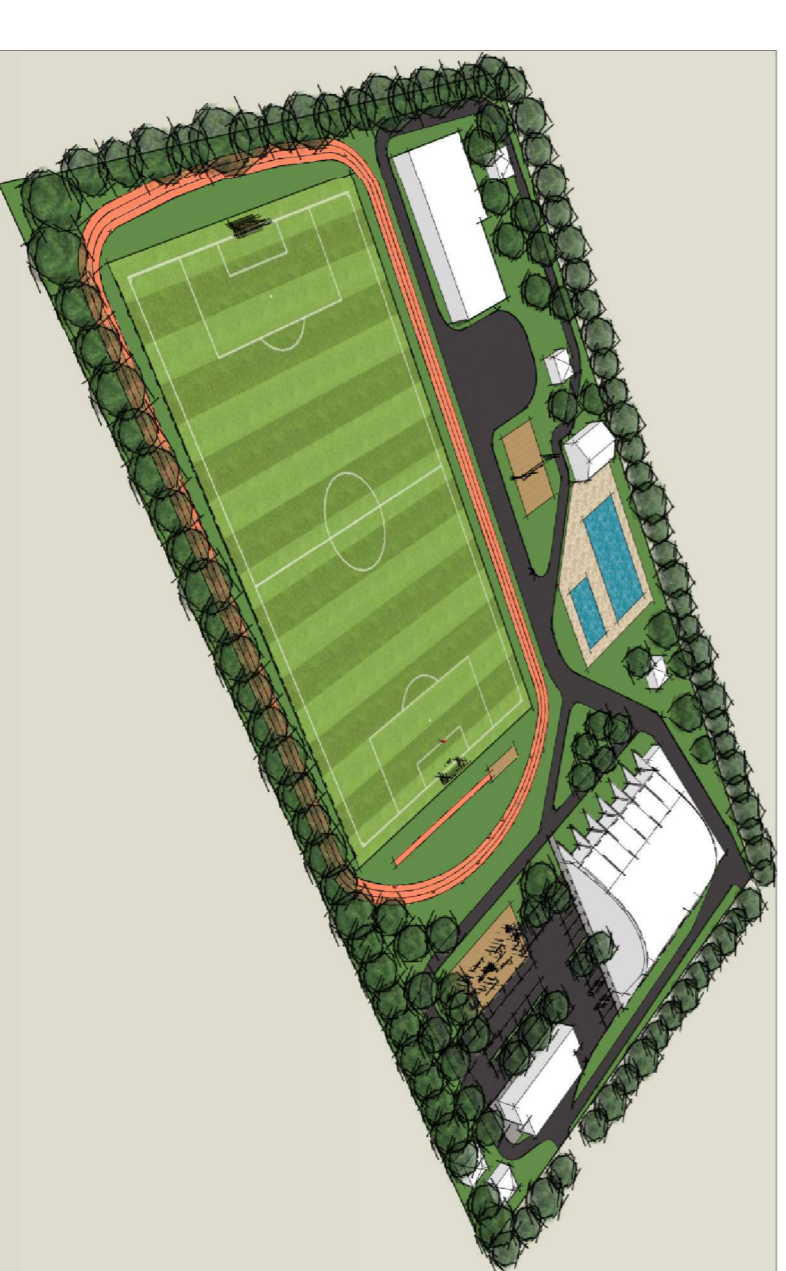
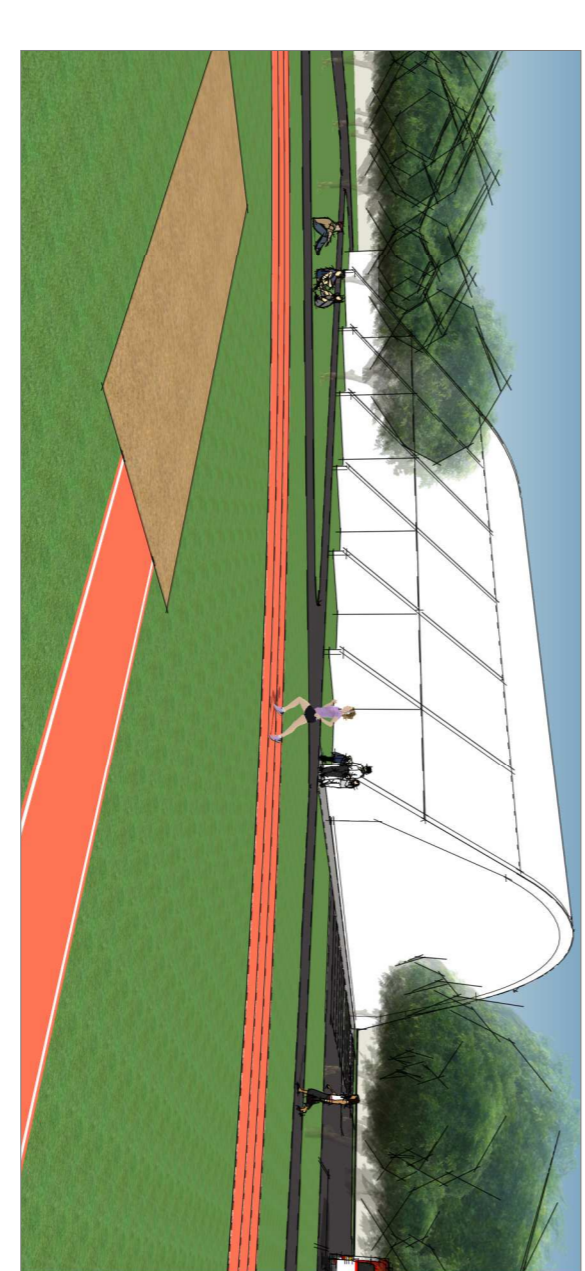
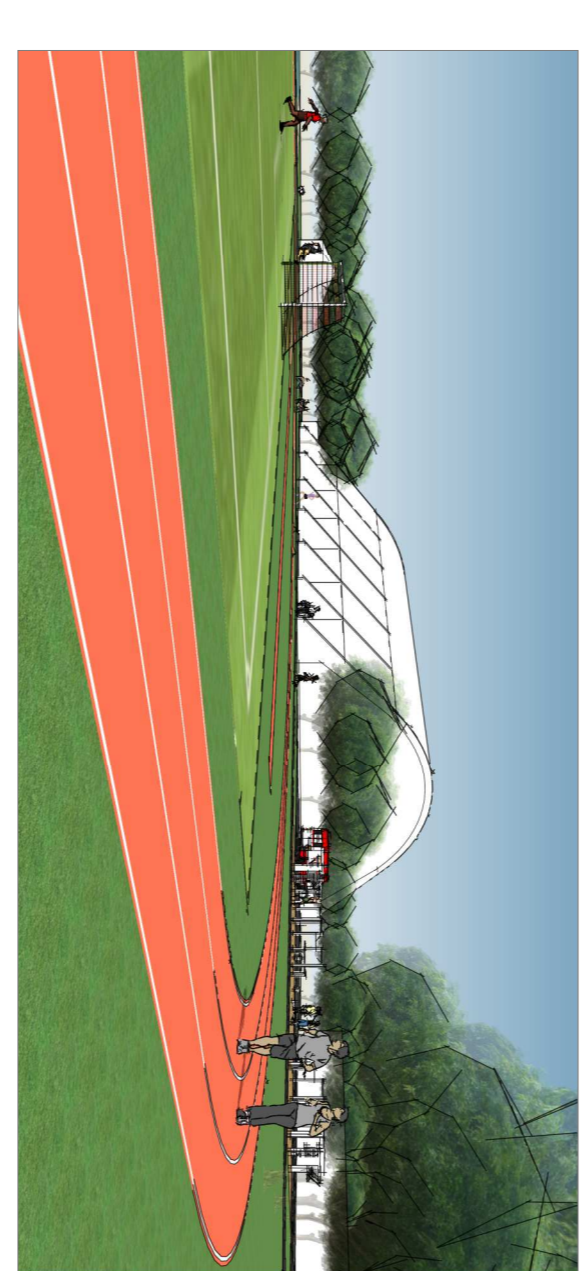
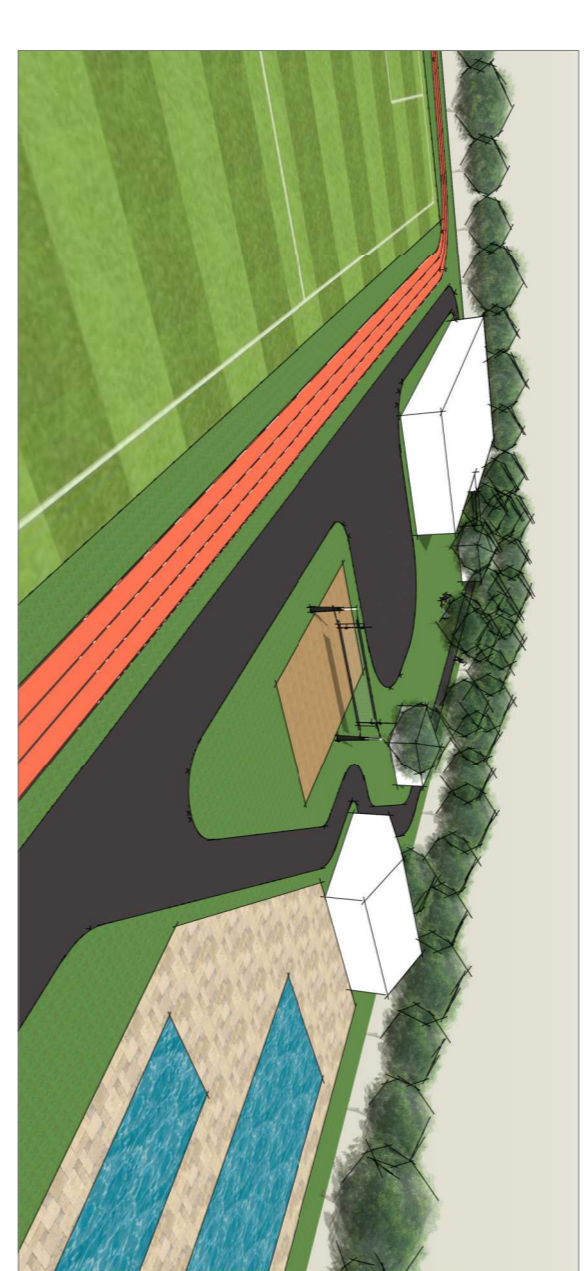
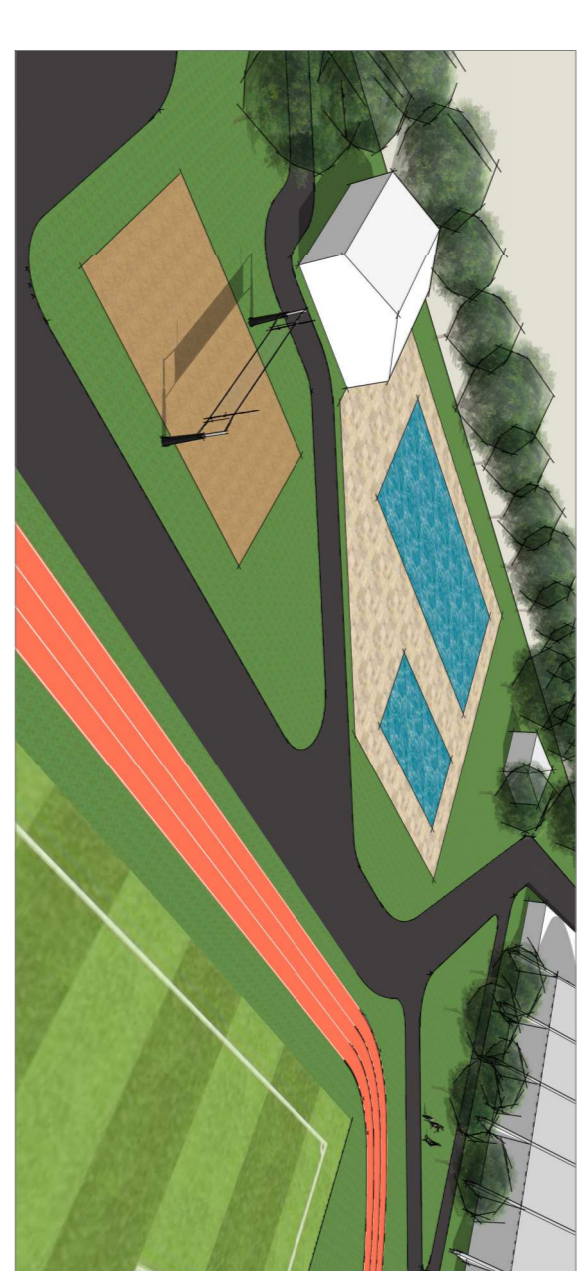
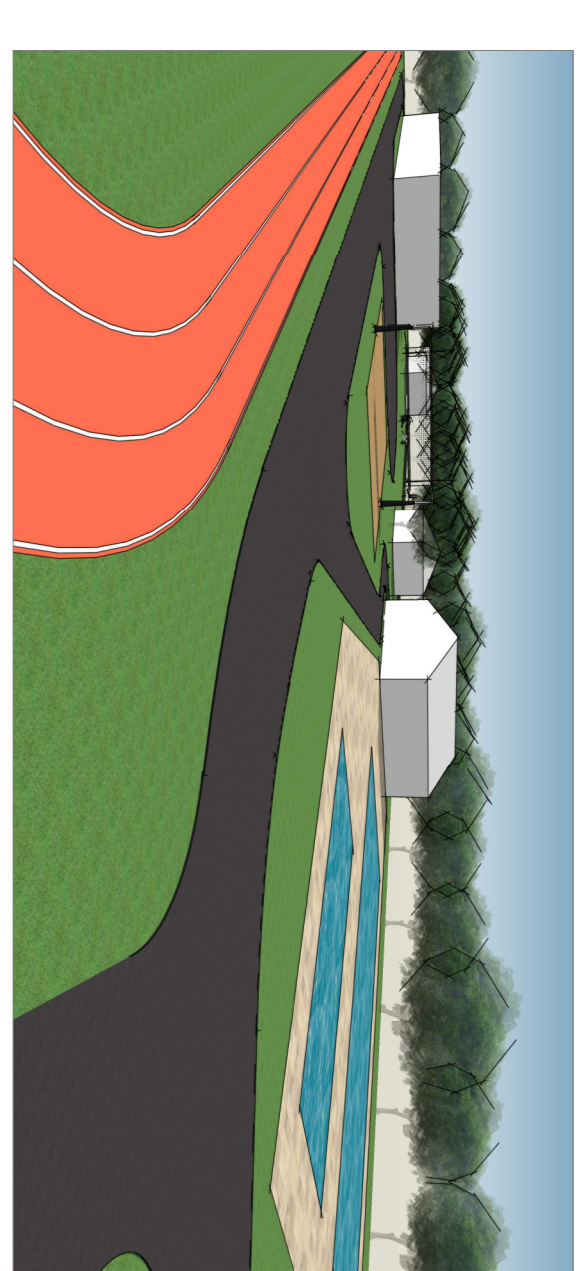

NOTAS:

PREFEITO  
RONALDO RIBEIRO VERANÇO

AUTOR DO PROJETO  
GILSON L. O. SANTOS  
CREA 5062053938  
ART 280272301/1419863

RESPONSÁVEL TÉCNICO  
GILSON L. O. SANTOS  
CREA 5062053938  
ART 280272301/1419863

NO	DATA	MODIFICAÇÃO
01		
02		
03		
04		
05		
06		

PISTA DE CAMINHADA E CORRIDA  
NO CENTRO DE LAZER DO TRABALHADOR

RUA OTÁVIO CASTAGNACCI, 180 - CENTRO

ESCALA INDICADAS

DESENHO: FILIPE TEIXEIRA

DATA: OUT/2018

FUNÇÃO: ARQUITETÔNICO

REV. 00

1/1